

PITELUMEC

THE PRING-E 178 RING BIT CASING SYSTEM



CASING SIZE 219MM OD X 194MM ID DRILLING DIA. 235MM

PNEUMEC PRING-E 178 CASING SYSTEM

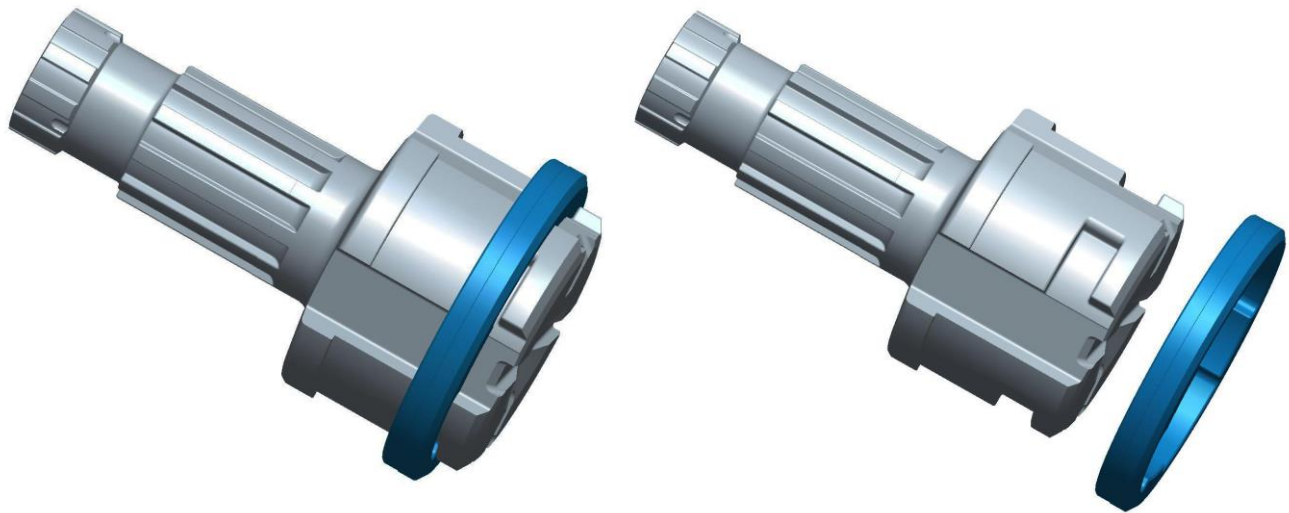

PRING-E 178 PARTS LIST

1.	DRIVER BIT DHD360 SHANK	UGD178360RE
2.	RING	URB190RE
3.	COMPLETE SYSTEM	UCS178360RE

PRING-E 178 SPECIFICATIONS

UPPER BODY DIAMETER	192MM	RING ID	146MM
RING OD	235MM	CASING SIZE	219MM OD X 194MM ID
SYSTEM LENGTH	524MM	SYSTEM WEIGHT	72KG

PRING-E 178 CASING SHOES

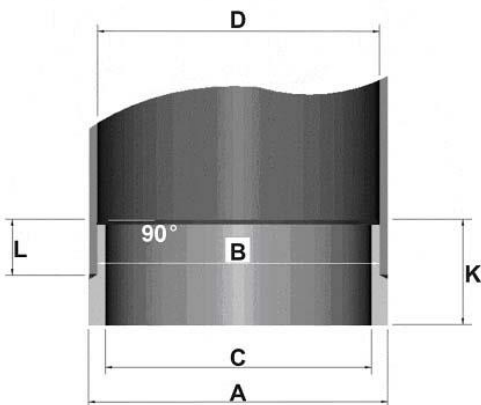

DIA. A	219MM
DIA. B	192MM
DIA. C	180MM
DIA. D	194MM
L	30MM
K	65MM



PNEUMEC COMPANY LIMITED

1st Floor, Tin On Sing Comm. Bldg., 41-43 Graham St. Central, H.K.

Tel : (852) 2178 9922

Website : www.pneumec.com

Fax : (852) 2178 9982

email : info@pneumec.com